



Perkins

Image for illustrative purposes only..



GENERATING SET MODEL (PZ30)

Output Ratings	Prime	Standby
380-415 V, 3 ph, 50 Hz, 1500 rpm	30 KVA	33 KVA
	24 KW	26 KW

ALTERNATOR DATA

Make	Stamford / Leroy Somer
Model	PI144G / TAL042C
No. of bearings	1
Insulation class	H
Total Harmonic Content	at no load <3% - on load <2%
Wires	12
Ingress Protection	IP23
Excitation System	SELF

ENGINE / TECHNICAL DATA

Ratings at 0.8 Power Factor

Engine Make	Perkins			
Engine Model	1103A-33G			
Governing Type	Mechanical			
Number of Cylinders	3			
Cylinder Arrangement	Vertical in line			
Bore and Stroke mm	105 x 127			
Displacement / Cubic Capacity litres	3.3			
Induction System	Naturally Aspirated			
Cycle	4 stroke			
Combustion System	Direct Injection			
Compression Ratio	19.25:1			
Rotation	Anti-clockwise (viewed from flywheel)			
Cooling System	Water - cooled			
Frequency and Engine Speed	50Hz & 1500rpm		60Hz & 1800rpm	
	Prime	Standby	Prime	Standby
Gross Engine Power kW (hp)	28.2 (37.8)	31.0 (41.6)	33.2 (44.5)	36.5 (48.9)
Fuel Consumption @ 50% load L/hr	3.9	-	4.9	-
@ 75% load L/hr	5.4	-	6.6	-
@ 100% load L/hr	7.1	7.9	8.6	9.5
Total Lubrication System Capacity litres	7.9	7.9	7.9	7.9
Total Coolant Capacity (inc. radiator) litres	10.2	10.2	10.2	10.2
Exhaust Temperature: °C	500	520	520	530
Radiator Cooling Air Flow (Min): m ³ /min	62.6	62.6	84.8	84.8
Combustion Air Flow: m ³ /min	2.2	2.2	2.6	2.6
Exhaust Gas Flow: m ³ /min	5.7	5.8	6.4	6.6
Fuel Tank Capacity: litres	150	150	150	150

CONTROL PANEL

Make	Deep Sea
Model	4000 SERIES

The **DSE 4000 Series** is an Auto Start Control Module for single genset applications. It includes a backlit LCD display which clearly shows the status of the engine all the times. This module can either be programmed using the front panel or by using the DSE configuration suite PC software.

Metering and Alarm indications:

- Generator frequency
- Underspeed, Overspeed
- Generator volts (L-L, L-N)
- Generator current
- Engine oil pressure
- Engine coolant temperature
- Fuel level (Warning or shutdown) - Optional
- Hours run counter
- Battery volts
- Fail to start/stop
- Emergency stop
- Failed to reach loading voltage/frequency
- Charge fail
- Loss of magnetic pick-up signal - Optional
- Low DC voltage
- CAN diagnostics and CAN fail/error

1. ENGINE

Perkins four stroke heavy duty high performance industrial type diesel engine.

2. ENGINE FILTRATION SYSTEM

- Cartridge type dry air filter.
 - Two Cartridge type fuel filters.
 - Full flow lube oil filter.
- All filters have replaceable elements.

3. COOLING RADIATOR

Radiator and cooling fan, complete with safety guards, designed to cool the engine at high ambient temperatures (consult your dealer for de-rating factors)

4. EXHAUST SYSTEM

Heavy duty Industrial Exhaust Silencer

Silencer noise reduction level	16 (dB)
Maximum allowable back pressure	8.0 (kPa)

5. CIRCUIT BREAKER TYPE

ABB 3 pole MCCB. (4 pole is optional)

6. FUEL SYSTEM

The baseframe design is incorporated with an integral fuel tank with a capacity of approx. 8 hours running at Full Load. The tank is supplied complete with fill cap breather, fuel feed and return lines to the Engine and drain plug.

7. ALTERNATOR

7.1 INSULATION SYSTEM

- The insulation system is Class H.
- All windings are impregnated in either a triple dip thermosetting liquid, oil and acid resisting polyester varnish or vacuum pressure impregnated with a special polyester resin.
- Heavy coat of antitracking varnish additional protection against moisture or condensation.

7.2 AUTOMATIC VOLTAGE REGULATOR (AVR)

The fully sealed Automatic Voltage Regulator maintains the Voltage Regulation at $\pm 1\%$. Nominal adjustment by means of a trim pot incorporated on the AVR.

7.3 MOTOR STARTING

An overload capacity equivalent to 300% of the Full Load impedance at zero Power Factor can be sustained for 10 seconds, when AREP or PMG option is fitted.

8. MOUNTING ARRANGEMENT

8.1 BASE FRAME

The complete Generating Set is mounted as a whole on a heavy duty fabricated steel Baseframe.

8.2 COUPLING

The Engine and Alternator are directly coupled by means of an SAE flange. The Engine flywheel is flexibly coupled to the Alternator rotor.

8.3 ANTI-VIBRATION MOUNTING PADS

Anti-Vibration pads are affixed between the Engine / Alternator feet and the Baseframe thus ensuring complete vibration isolation of the rotating assembly.

8.4 SAFETY GUARDS

The Fan & Fan Drive along with the Battery Charging Alternator are Safety Guard protected for personnel protection.

9. FACTORY TEST

- The Generating set is load tested before dispatch
- All protective devices control functions and site load conditions are simulated. The generator and its systems are checked before dispatch.

10. EQUIPMENT FINISHING

All mild steel components are fully degreased and painted with powder coated paint to ensure maximum scuff resistance and durability.

11. DOCUMENTATION

Operation & Maintenance manual, Circuit wiring diagrams and Commissioning / Fault Finding instruction leaflets are accompanied with the Generator.

12. QUALITY STANDARDS

The equipment meets the following standards: BS4999, BS5000, BS5514 IEC 60034, VDE0530, NEMA MG 1.22 and ISO 8528.

13. WARRANTY

All of the Generating Sets are covered under a warranty policy for a period of 12 months. Warranty of the equipment is in line with manufacturers warranty terms & conditions.

(check warranty statement for more details, as it may vary for different countries)

In line with continuous product development, we reserve the right to change specifications without notice.

STANDARD REFERENCE CONDITIONS

Prime Power

These ratings are applicable for supplying continuous electrical power (at variable load) in lieu of commercially purchased power. 10% overload power is available for 1 hour in 12 hours continuous operation.

Standby Power

These ratings are applicable for supplying continuous electrical power (at variable load) in the event of a utility power failure. No overload is permitted on these ratings.

DIMENSIONS AND WEIGHT

Length cm	Width cm	Height cm	Weight* kg (wet)
153	66	135	700

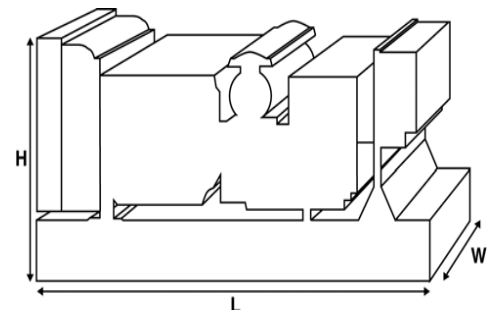

Dealer contact details:



Engineering & Services

**1P, 1KM, Defence Off
Raiwind Road, Bhubtian
Chowk, Lahore.**

www.powerzone.com.pk

info@powerzone.com.pk

UAN: (042) 111-111-087

**Office# 7&8, 1st Floor,
Block 76-E, Hill View
Plaza, Jinnah Avenue,
Sector G-7 & F-7, Blue
Area, Islamabad.**

UAN: (051) 111-111-087